

ART 708-A MK4

ACTIVE TWO-WAY SPEAKER

DESCRIPTION

ART 708-A MK4 is a unique product in its category. The 1.0" compression driver offers unique vocal clarity and sound projection. The 8" woofer offers an extremely linear response and a precise, deep low frequency control. The transducers are produced using the most advanced assembly technologies. The amplifier delivers 800 watts and is controlled by a DSP that takes care of crossover, equalisation, phase control, soft limiting and speaker protections.



FEATURES

- 127 dB Max SPL
- 800 WATT 2-way peak power
- 90 x 70, Wide dispersion constant directivity horn
- Innovative DSP Processing
- 1" Compression Driver, 1.0" v.c.
- 8" Woofer
- FiRPHASE Technology

TECHNICAL SPECIFICATIONS

| | | |
|----------------------------------|----------------------------|-------------------------|
| Acoustical specifications | Frequency Response: | 60 Hz ÷ 20000 Hz |
| | Max SPL @ 1m: | 127 dB |
| | Horizontal coverage angle: | 90° |
| | Vertical coverage angle: | 70° |
| Transducers | Compression Driver: | 1 x 1.0", 1.0" v.c |
| | Woofers: | 8", 2.0" v.c |
| Input/Output section | Input signal: | bal/unbal |
| | Input connectors: | XLR, Jack |
| | Output connectors: | XLR |
| | Input sensitivity: | -2 dBu/+4 dBu |
| | Mic. Input Sensitivity: | -32 dBu |
| Processor section | Crossover Frequencies: | 1600 Hz |
| | Protections: | Thermal, RMS |
| | Limiter: | Soft Limiter |
| | Controls: | Volume, Boost, Mic/Line |
| Power section | Total Power: | 800 W Peak, 400 W RMS |
| | High frequencies: | 200 W Peak, 100 W RMS |
| | Low frequencies: | 600 W Peak, 300 W RMS |
| | Cooling: | Convection |
| | Connections: | VDE |
| Standard compliance | CE marking: | Yes |
| Physical specifications | Cabinet/Case Material: | PP Composite |
| | Hardware: | 2 x M10 |
| | Handles: | 1 Top |
| | Pole mount/Cap: | Yes |
| | Grille: | Steel |
| | Color: | Black |
| Size | Height: | 480 mm / 18.9 inches |
| | Width: | 291 mm / 11.46 inches |
| | Depth: | 276 mm / 10.87 inches |
| | Weight: | 10.4 kg / 22.93 lbs |
| Shipping informations | Package Height: | 520 mm / 20.47 inches |
| | Package Width: | 331 mm / 13.03 inches |
| | Package Depth: | 346 mm / 13.62 inches |
| | Package Weight: | 12.2 kg / 26.9 lbs |



PART NUMBER

• **13000519**

ART 708-A MK4

115V

EAN 8024530015077

• **13000518**

ART 708-A MK4

220-240V

EAN 8024530014803

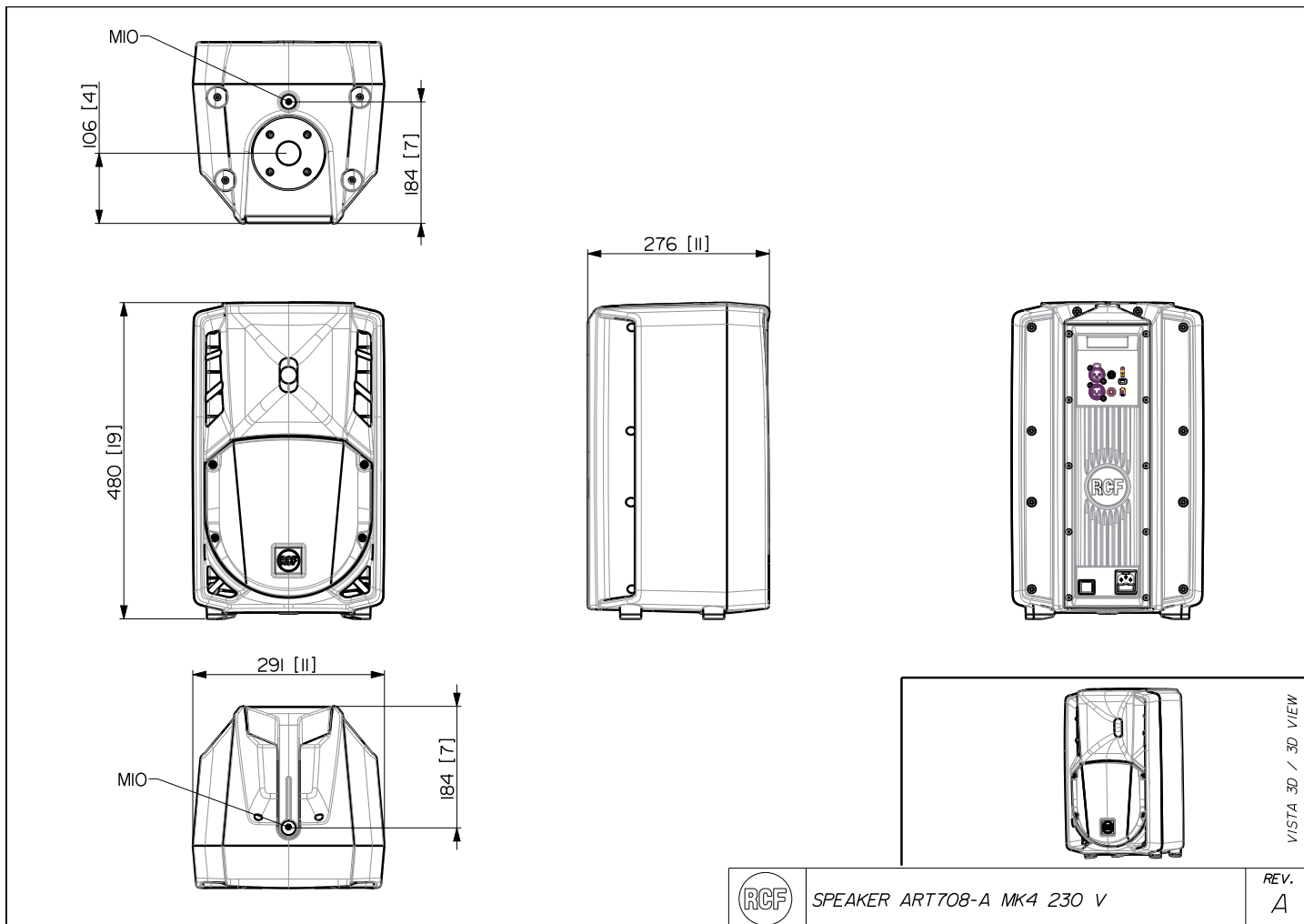

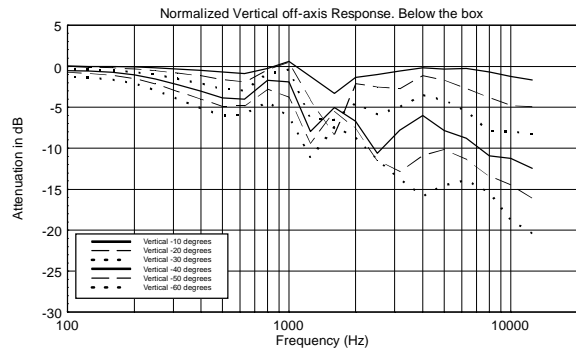
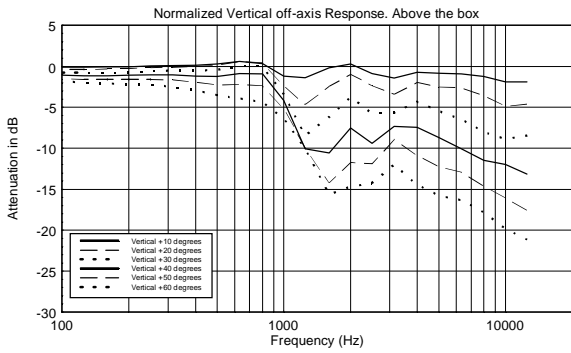
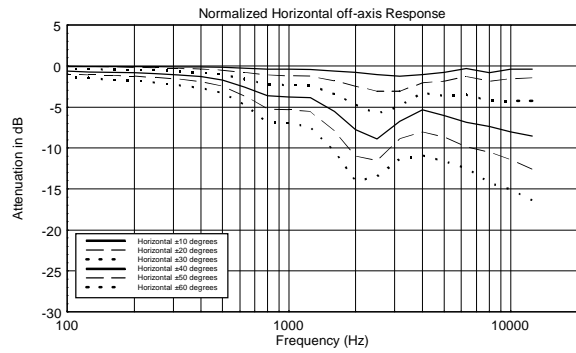
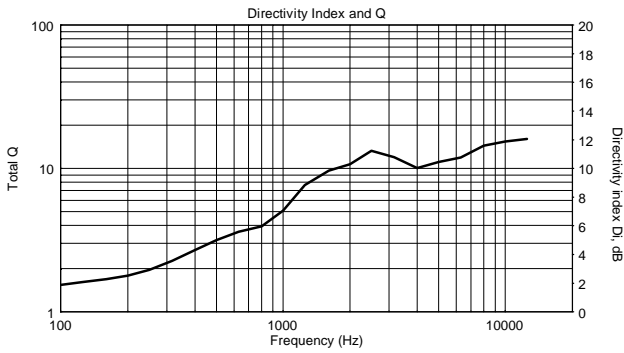
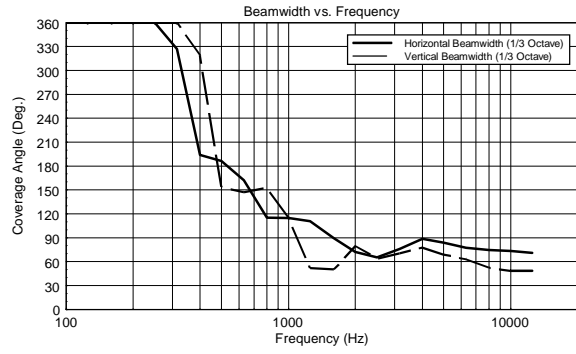
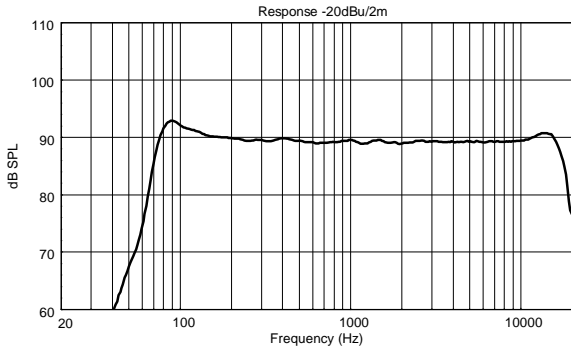

Horizontal 1/3 Octave Polars

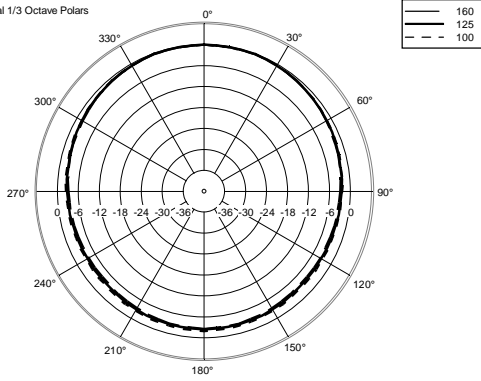

Horizontal 1/3 Octave Polars

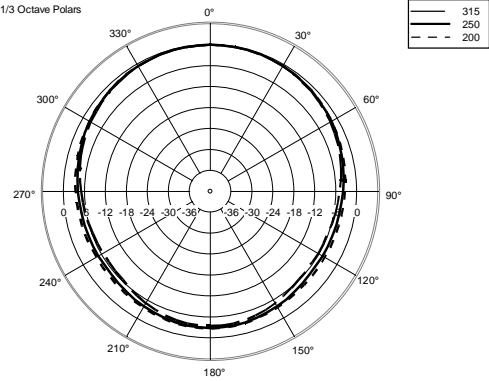

Horizontal 1/3 Octave Polars

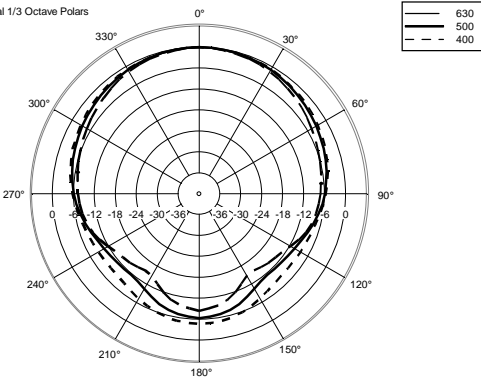

Horizontal 1/3 Octave Polars

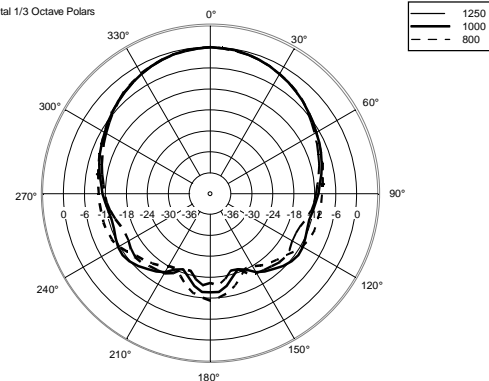

Horizontal 1/3 Octave Polars

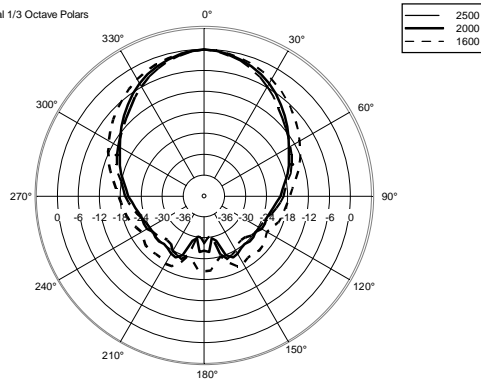

Horizontal 1/3 Octave Polars

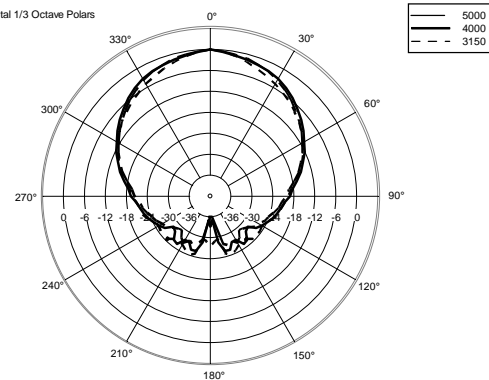

Horizontal 1/3 Octave Polars

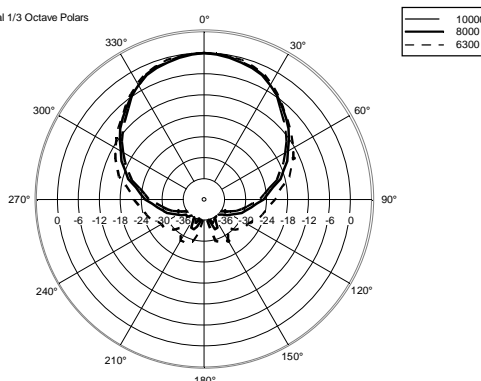

Horizontal One Octave Polars

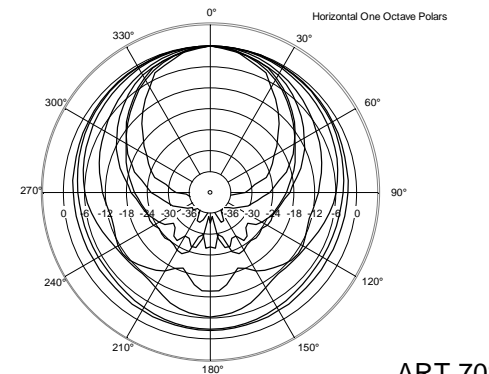

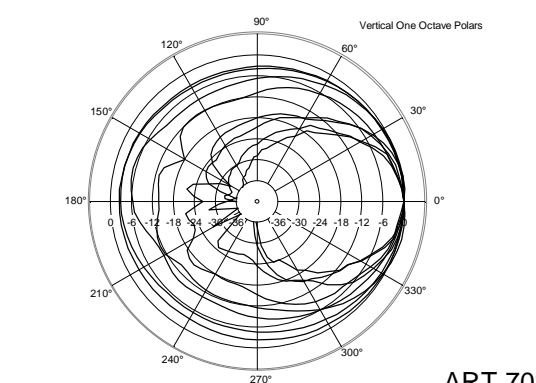
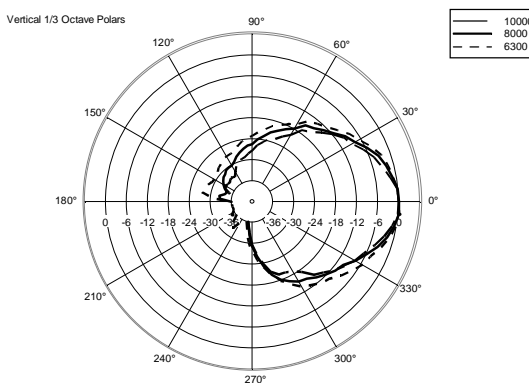
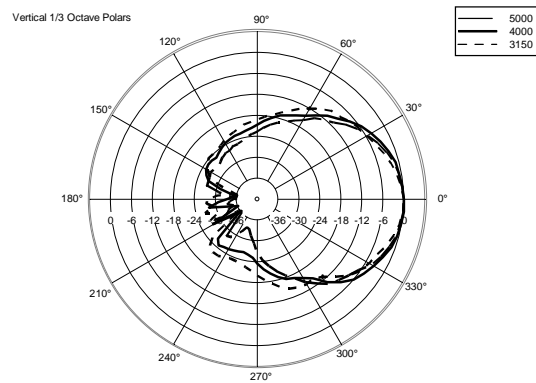
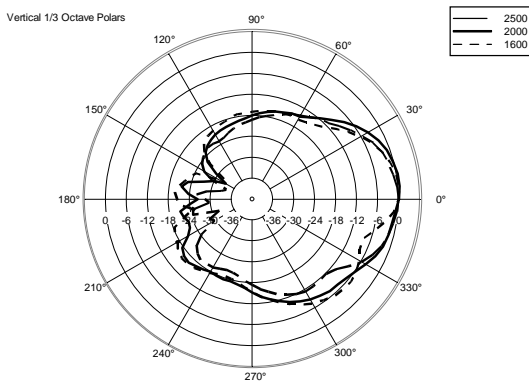
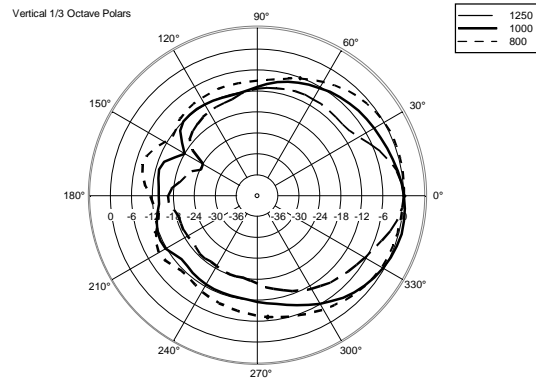
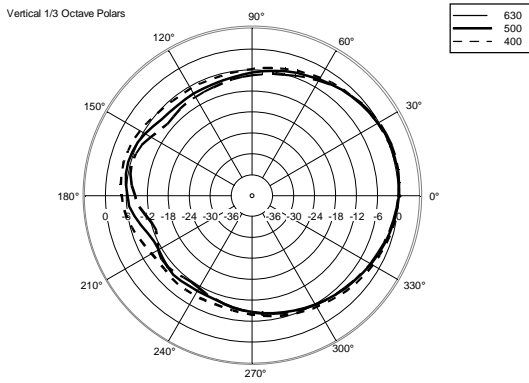
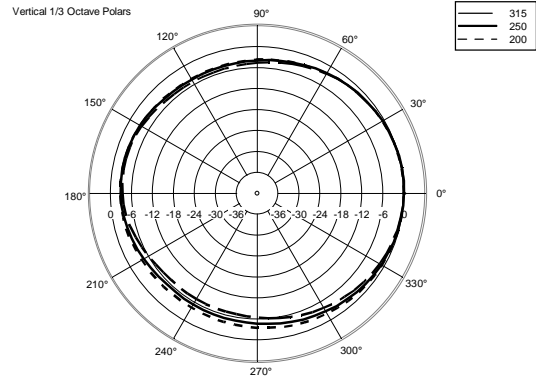
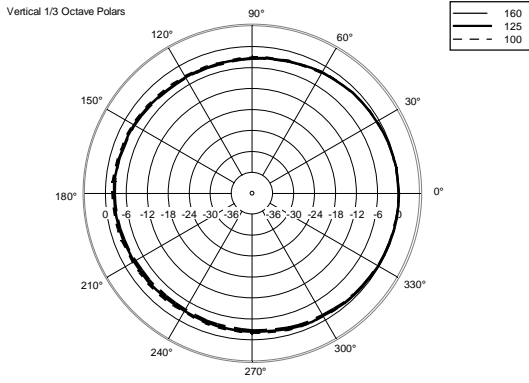

ACCESSORIES

AC PMA - POLE MOUNT

PART NUMBER **13360034**
EAN: 8024530007713

AC PM-M20

PART NUMBER **13360067**
EAN: 8024530014599

AC PMX POLE MOUNT M20

PART NUMBER **13360232**
EAN: 8024530010058

AC PRO-FS PROFESS. LOCKING FLOOR STAND

PART NUMBER **13360109**
EAN: 8024530006471

AC PRO-PM PROFESS. LOCKING POLE MOUNT

PART NUMBER **13360110**
EAN: 8024530006488

COVER CVR ART 708

PART NUMBER **13360166**
EAN: 8024530010706